

## Efficient Modulation Formats for High Bit-Rate Fiber Transmission

A. García-Pérez\*, J. A. Andrade-Lucio\*, O. G. Ibarra-Manzano\*, E. Alvarado-Méndez\*, M. Trejo-Duran\* and H. Gutiérrez-Martín\*

### ABSTRACT

The topic of this report will deal with the study of advanced modulation formats for high-speed optical communication systems. Basically, the use of alternate polarization modulation (aIP) is considered in order to reduce the inter-symbol interference (ISI) caused mainly by effects such as Chromatic Dispersion (CD), Polarization Mode Dispersion (PMD) and Nonlinear effects. The comparative analysis among the different formats is carried out by means of the obtaining of its different spectrums. A detailed analysis of these and their dependency to the modulation format that generates it is presented. The article presents numerical comparative analysis using commercial software *VPI Maker Transmission*, where the results obtained show that the formats of alternating polarization are the best results at the bit rate of 40 Gb/s per channel.

### RESUMEN

El tópic de este reporte incluye el estudio de formatos de modulación avanzada para sistemas de comunicación óptica de alta velocidad. Básicamente, el uso de modulación por polarización alternante es considerada por que reduce la interferencia entre símbolos causada principalmente por efectos como Dispersión Cromática (CD), Dispersión por modo de polarización y efectos no lineales. El análisis comparativo entre los diferentes formatos se realiza mediante la obtención de sus diferentes espectros. Un análisis detallado de éstos y su dependencia al formato de modulación que lo genera es presentado. El artículo presenta análisis comparativo numérico utilizando el paquete comercial *VPI Maker Transmission*, donde los resultados obtenidos muestran que los formatos de polarización alterna presentan los mejores resultados a la velocidad de 40 Gb/s por canal.

Recibido: 5 de Abril de 2006  
Aceptado: 4 de Agosto de 2006

### INTRODUCTION

The capacity of optical communication systems is rising exponentially in order to follow the rapidly increasing demand for data traffic. Limitations due to dispersion and nonlinearities in the optical fiber become more stringent for higher bit rates. Most commercial systems use the NRZ modulation format (Hayee, 2003). However, an increasing effort on research is being carried out on alternative modulation formats, particularly the Return-to-Zero (RZ) format which has received considerable attention in the past years (Hodžić, 2002). Dispersion compensation is an essential part of any high-speed long-haul communication system (Jopson, 1995). The most commonly used dispersion compensation scheme is the dispersion compensation fiber (DCF). DCF is the dispersion compensation scheme used in our simulations together with new advanced modulation formats.

For the next generation of optical communication systems to fulfill future capacity demands, state-of-the-art dispersion management will be required to effectively compensate for dispersion in a wide bandwidth and minimize nonlinear signal degradation. Advanced modulation formats can be used to improve the transmission performance and to achieve high spectral efficiency (Hoshida, 2002; Wuth, 2001). We study different modulation formats at per channel bit rates of 40 Gb/s, and compare their relative performance in systems with various 80 km single mode fiber (SMF) + DCF fiber spans. Computer simulations (VPI software, 2002) are used to compare the RZ, NRZ, NRZ-DPSK, RZ-DPSK, aIP-NRZ, aIP-RZ and aIP-RZ-DPSK modulation formats for single channel systems.

#### Keywords:

Fiber optic; Modulation; Communications.

#### Palabras clave:

Fibra óptica; Modulación; Comunicaciones.

\* Facultad de Ingeniería Mecánica, Eléctrica y Electrónica de la Universidad de Guanajuato. Salamanca, Gto. México. Departamento de Electrónica.  
Correo electrónico: arturo@salamanca.ugto.mx

## IMPLEMENTATION OF ADVANCED MODULATION TRANSMITTERS

The modulation format describes how the data is coded onto the optical signal. Four properties of an optical signal can be modulated: The amplitude, phase, frequency and state of polarization (SOP). Most systems today use a binary amplitude modulation format with a pulse width equal to the time slot NRZ, since is very simple (and the cheapest) transmitters and receivers can be used. It has been known that using a RZ waveform can improve the receiver sensitivity and nonlinear tolerance, but at the extra cost of one additional modulator and drive circuitry in the transmitter (Furst, 2000). Recently, many modulation formats with additional phase modulation have been shown to perform very well under certain circumstances, for example chirped RZ (Xu, 2003; Hui, 2001). This however, adds further complexity to the transmitter. Recently, phase modulation has been “rediscovered” in the optical communication field. Phase modulation combined with a balanced receiver offers a very attractive 3 dB improved receiver sensitivity compared to On-Off-Keying (OOK) (Wang, 2004; Zacharopoulos, 2004).

The various modulation formats can be classified into the following four categories, depending on which of the four properties of the electric field of optical carrier belongs:

$$E(t) = \hat{e}Ae^{j(\omega t + \vartheta)} \quad (1)$$

A : Amplitude shift keying (OOK),  $\vartheta$ : Phase shift keying,  $\omega$  : Frequency shift keying,  $\hat{e}$  : Polarization shift keying.

In this report, modulation formats from the first, second and fourth group listed above have been investigated. These parameters can be modulated by an electrical binary baseband signal  $m(t)$  as:

$$m(t) = \sum_{j=-\infty}^{\infty} m_j \cdot g(t - jT_b) \quad (2)$$

Where  $m_j$  is the information coefficients and  $g(t)$  is the baseband pulse shape delayed by multiples of the bit period  $T_b$ . Depending of which parameter is modulated; there can be generated different modulations as polarization shift keying (PolSK) or aIP. aIP is the most exotic modulation format among all new advanced modulation formats. The aIP is generated by switching the signal polarization between two orthogonal states of polarization and is characterized by a constant signal envelope that provides better nonlinear impairments tolerance, improved sensitivity compared to OOK modulation.

### NRZ Modulation

The non-return-to-zero (NRZ) has been the dominant modulation format in intensity modulated-direct detection (IM/DD) fiber-optical communication systems for the last years. The reasons for using NRZ in the early days of fiber-optical communication were: a) it is not sensitive to laser phase noise (compared to PSK); b) it requires a relatively low electrical bandwidth for transmitters and receivers compared with RZ; c) it has the simplest configuration of transmitter and receiver. Unfortunately, this modulation format is not suitable for high bit rate and long distances. NRZ would be a

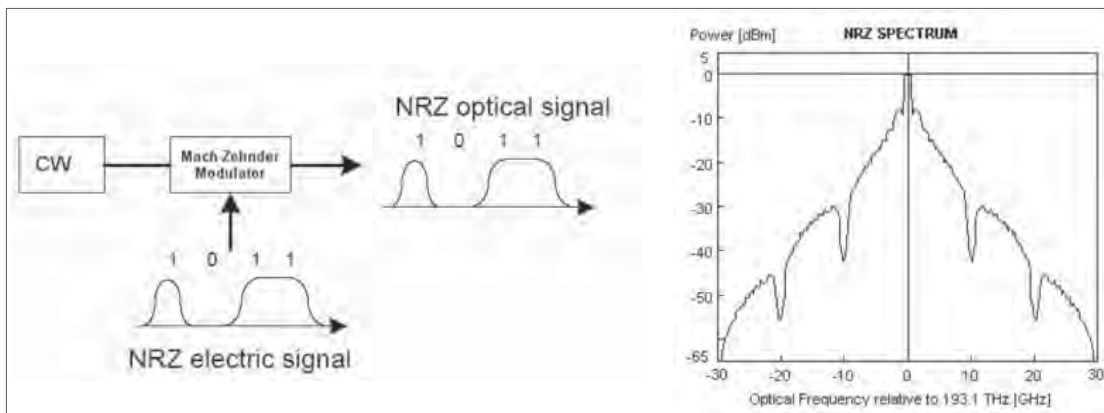

Figure 1. NRZ transmitter diagram and its spectrum.

good reference for the purpose of comparison due to its historic application. The Figure 1 shows the diagram of the NRZ transmitter and the spectrum of the modulated signal. The intensity of the carrier light wave is modulated by the applied electric field which voltage varies with a determined function. The Mach-Zehnder modulator (MZM) is driven at the quadrature point of the modulator power transfer function with an electrical NRZ signal. We can see that the spectrum has a strong carrier component and there are deep nulls at the multiples of the bit rate. We can see from Figure 1 that the carrier frequency contains too much power but no information. Thus, techniques to reduce the power content of the signal are necessary.

The NRZ pulses possess a narrow optical spectrum due to the lower on-off transitions. The reduced spectral width improves the dispersion tolerance, but on the other hand it affects the inter-symbol interference (ISI) between the pulses. This is evident for isolated spaces between sequences of marks where the energy of neighboring marks becomes transformed in the time slot of the isolated space resulting in ISI effects.

### RZ Modulation

The RZ pulse occupies just a part of the bit slot, so it has a duty cycle smaller than 1 and a broad spectrum. Figure 2 shows the RZ transmitter and its spectrum. The RZ signal amplitude between adjacent 1's returns to zero. A RZ signal with the same average power of a NRZ signal has a spectrum peak-power twice larger. The main characteristic of RZ modulated signals is a relatively broad optical spectrum, resulting in a reduced dispersion tolerance and a reduced spectral efficiency. The RZ pulse shape enables an increased robustness to fiber nonlinear effects and to the effects of PMD. The mathematical representation of a generated RZ signal is

$$E_{out}(RZ) = \frac{1}{2} E_{in}(t) \left( e^{j\left(\frac{\pi(0.1\sin(2\pi ft) + \pi(1))}{1}\right)} + e^{-j\left(\frac{\pi(0.5\sin(2\pi ft) + \pi(-1))}{1}\right)} \right) \quad (3)$$

$$= -\cos(0.314159\sin(2\pi ft))$$

The RZ signal spectrum has a width of 20 GHz between the first two sidebands. We can see in Figure 2 that a reduction in power content of the RZ modulated carrier is apparent compared to NRZ modulation. However, the carrier frequency still contains much power but no information. The RZ modulation would be a better candidate than NRZ for 40 GB/s WDM transmissions because of its better nonlinear robustness. The RZ performs better than NRZ because the energy is confined in the center of each bit-slot in the case of RZ case and that more differential group delay (DGD) is required before the energy leaks out the bit-slot to result in inter-symbol interference.

### CSRZ Modulation

CSRZ is a special form of RZ where the carrier is suppressed. The main target of this modulation format is a reduction of the nonlinear impairments in a channel and an improvement of the spectral efficiency in high bit rate systems. The difference between CSRZ and conventional RZ is that the CSRZ signal has a  $\pi$  phase shift between adjacent bits. This phase alternation, in the optical domain, produces no DC component; thus, there is no carrier component for CSRZ. It can be expected that the dispersion tolerance of CSRZ modulation can be improved due its reduced spectral width compared to RZ modulation. In general, the generation of a CS-RZ optical signal requires two electro-optic modulators as shown in Figure 3. The first MZ modulator encodes the NRZ data. Then the generated NRZ optical signal is modulated by the second MZ modulator to generate a CSRZ optical signal.

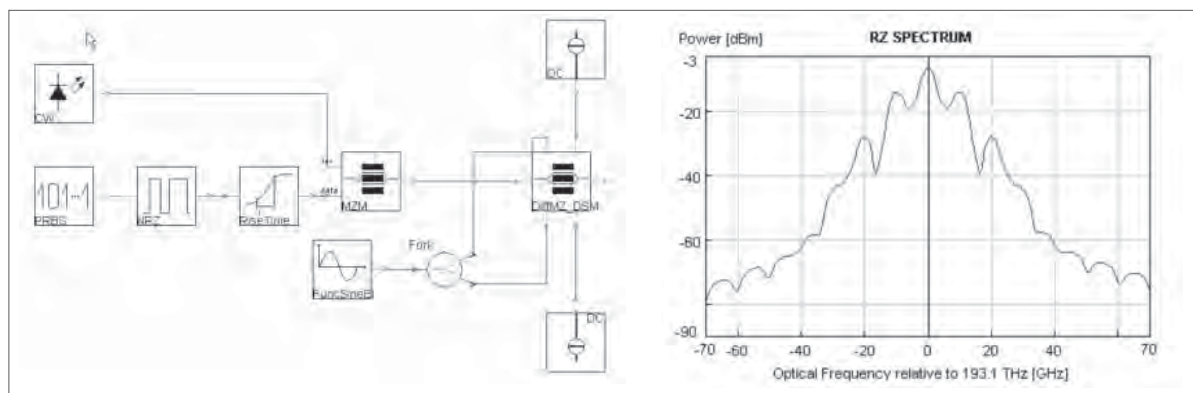

Figure 2. RZ transmitter and its spectrum.

The mathematical representation of generated CSRZ signal is

$$E_{out}(CSRZ) = \frac{1}{2} E_m(t) \left( e^{j\left(\frac{\pi(0.5\sin(2\pi ft) + \pi)}{1}\right)} + e^{j\left(\frac{\pi(0.5\sin(2\pi ft) + \pi(-1))}{1}\right)} \right) \quad (4)$$

$$= -j \sin(1.5708 \sin(2\pi ft))$$

We can see in the spectrum that the carrier component is suppressed and the spectral width between two first sidebands amount to 40 GHz. This represents a reduction in the spectral width by a factor of two, compared to spectral width between two first sidebands in the RZ case. The carrier component of CSRZ signal spectrum is suppressed due to the external modulation at zero point in the second MZM. The spectrum shows two sidebands that carry the information and also, other two upper and lower second harmonic sidebands.

### RZ-DPSK Modulation

DPSK encodes information using the phase difference between two neighboring bits. If  $\phi_k$  represents the phase of the  $n$ th bit, the phase difference is changed by 0 or  $\pi$ , depending on whether the  $n$ th bit is a '0' or '1' bit. A very important characteristic of RZ-DPSK is that its signal power is always constant. Figure 4 shows the simulated set-up and its spectrum for RZ-DPSK modulation. In this modulation format, this signal power is not constant as in the NRZ-DPSK; this will probably introduce the sensitivity to nonlinearities as SPM. However, similar to CSRZ, RZ-DPSK is more tolerant to data-pattern dependant SPM-GVD effect with optimal dispersion compensation because of its regular RZ waveform.

### CSRZ-DPSK Modulation

The significant progress made on DPSK modulation, where all formats of OOK were tried onto the phase of

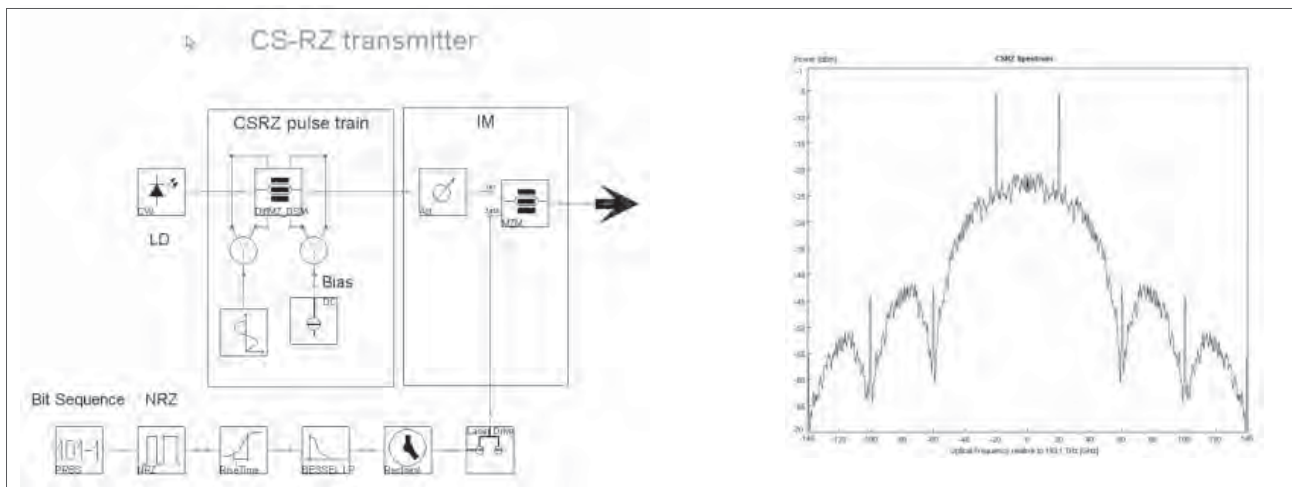

Figure 3. CSRZ transmitter and its spectrum.

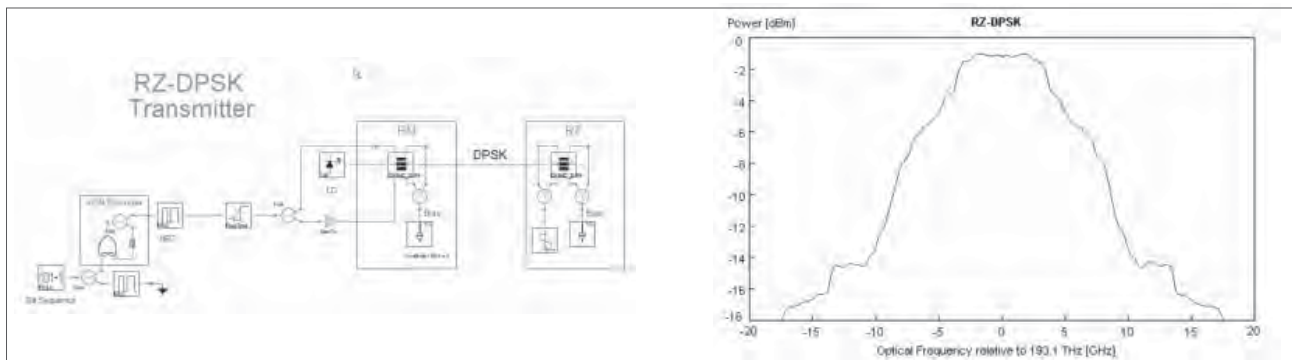

Figure 4. RZ-DPSK transmitter and its spectrum.

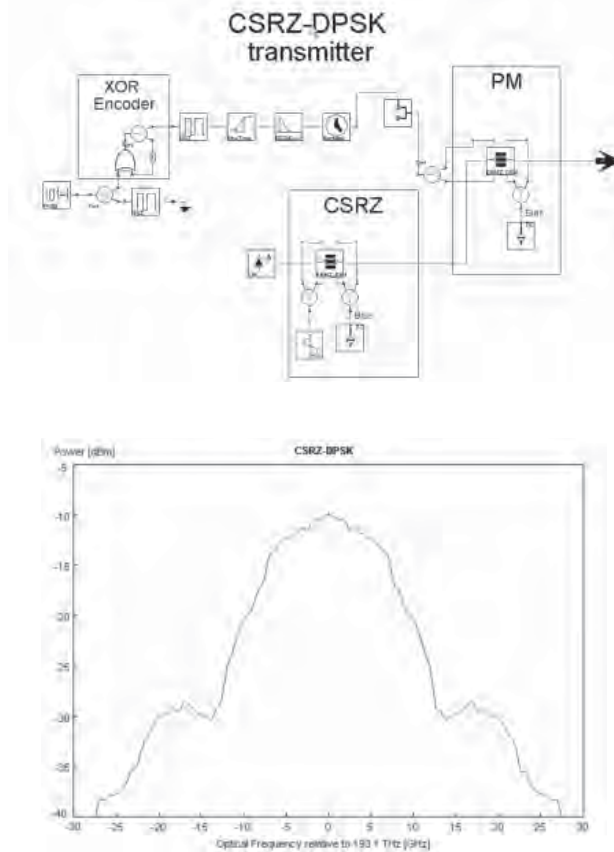

Figure 5. CSRZ-DPSK transmitter and its spectrum.

the optical carrier. However, CSRZ-DPSK offers similar improved performance according to publications over its NRZ counterparts. Figure 5 shows the simulation set-up of CSRZ-DPSK system. The transmitter consists of a laser, followed by two dual-drive intensity modulators. This method produced phase modulation with a near-perfect 180° phase shift. The CSRZ-DPSK pulses possess a RZ signal shape and due to the reduced spectral width, CSRZ-DPSK modulations show an increased dispersion tolerance and it is more robust to nonlinear impairments than conventional RZ format.

### Alternate Polarization modulation

Polarization-switched modulation provides a better suppression of nonlinear system degradations than RZ modulation. The polarization switching between adjacent bits disables power interactions between them, resulting in a lower pulse interaction and a larger nonlinear tolerance. At the same time, the orthogonal polarization between bits is maintained over long transmission distances independently of PMD impacts in the transmission line. Using alternating polarizations to modulate NRZ or RZ formats is expected that the orthogonality will be maintained even in the presence of PMD; due to the frequency dependence of all PMD effects are avoided. The signal detection is done with a conventional NRZ detector. The polarization switching between adjacent RZ pulses is realized by the polarization modulation of pulses in an additional polarization modulator (PolM) shown in Figure 6. The polarization state of the optical signal is adjusted to a linear polarization (angle of 45°) at the PolM input by a polarization controller (PC). In the polarization beam splitter (PBS) a RZ signal is separated into x- and y- polarization components. The modulation of y- polarization component is realized in the phase modulator (PM).

The PM was driven by an electrical bit pattern with alternating bits (1010101010...). If the drive signal is a mark, the phase of the y- polarization component will be shifted by 180° causing a polarization switching of 90° degrees in the total signal polarization. This results in a pulse polarization angle of -45° after the polarization beam combiner. When the drive signal is a space at the input of PM, no phase modulation occurs and the total pulse polarization at the PolM output remains unchanged (45°). The two polarization components are joined with a polarization beam combiner (PBC). Figure 7 shows the optical spectrum of 40 Gb/s aIP-NRZ and aIP-RZ pulses that have NRZ and RZ like pulse shapes respectively. However, the alternating polarization spectrums are broader than conventional NRZ and RZ spectrums. This can be explained by the fact that the spectrum of alternating polarized signals is composed by a superposition of two polarization components with different optical spectrum. The spectrum of x- polarization

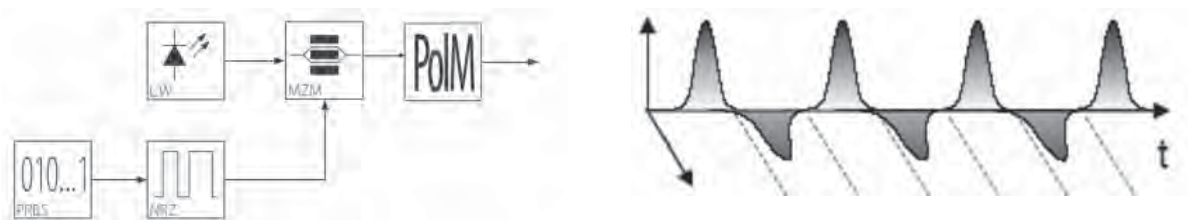

Figure 6. Transmitter used for alternating polarization modulation and the alternate polarization signal.

tion is a CSRZ component due to the employed phase modulation, whereas  $y$ -polarization is conventional NRZ spectrum in the case of aIP-NRZ format.

### SIMULATIONS SETUPS FOR 40 GB/S ADVANCED MODULATION FORMATS

The optimization of components characteristics and systems settings in 40 Gb/s single channel transmission is required. In order to provide the conditions for future system design, it would be necessary to consider the characteristics of single transmission components and their interaction with different transmission impairments. The system setting optimization is provided for different ASK and PSK modulation techniques considering effects such as input powers in transmission and dispersion compensation fibers.

Transmissions at 1550 nm were investigated for different advanced modulations formats. All ASK modulation formats use an identical direct detection receiver and PSK modulations formats use a balanced direct detection receiver. The lowpass electrical filter has a 3rd order and a bandwidth of 28 GHz. The transmission line is made of 80 Km long spans because this span length is favorable by network providers and represents a good compromise between linear and non-linear limitations. The spans consists of nonzero dispersion shifted fiber (NZDSF) because provide a better transmission performance in 40 Gb/s single channel transmission and dispersion compensation fiber (DCF). The optical amplification is done by the use of EDFA with a noise figure of 4 dB. An optical band-pass filter is placed after the last EDFA with a 3-dB bandwidth of 160 GHz ( $4 \times \text{Bit rate}$ ) in order to suppress ASE noise effects before signal detection.

The accumulated dispersion is fully compensated by DCFs on a span-by-span basis. This method can be considered as a worst case scenario because the system performance in 40 Gb/s single channel transmission can be improved by applying pre-compensation at the transmitter side and post-compensation at receiver side.

Direct detection DPSK signal is the most popular coherent optical communication receiver. Figure 8 shows the simulation set-up implemented for the reception of DPSK modulation formats (DPSK, RZ-DPSK, CSRZ-DPSK, aIP-DPSK, aIP-RZ-DPSK and aIP-CSRZ-DPSK). The decoder structure consists of a MZ interferometer, with a delay equal to the symbol period ( $1/\text{BitRate}$ ) and a balanced receiver (two PIN photodiodes), which creates a power difference between the signals from the two output ports. The alternating polarized signal requires a MZ interferometer, with a delay equal to  $2/\text{BitRate}$ .

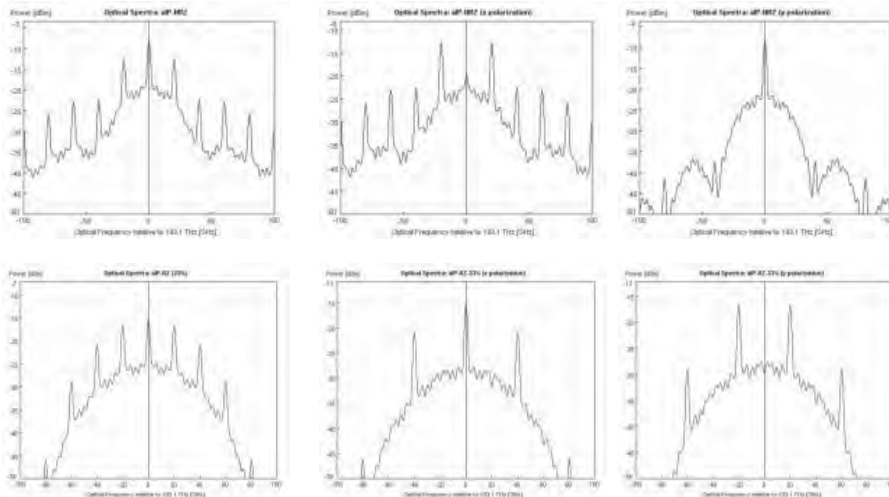

Figure 7. 40 Gb/s aIP-NRZ and aIP-RZ signals: a) Spectrums, b) X-polarization, c) Y-polarization.

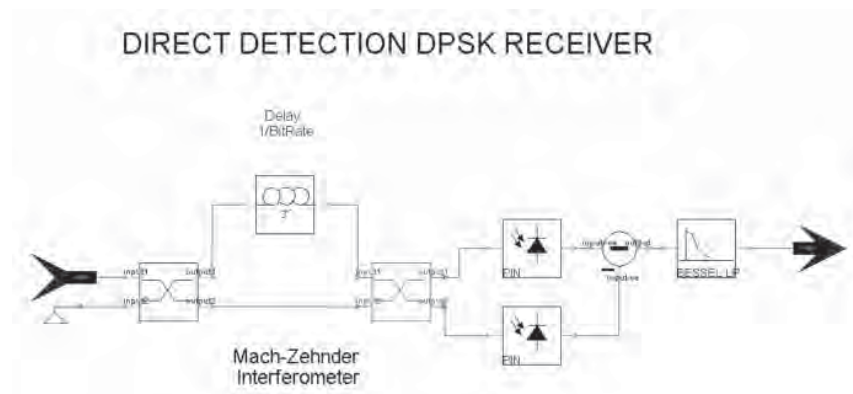

Figure 8. Direct Detection DPSK receiver.

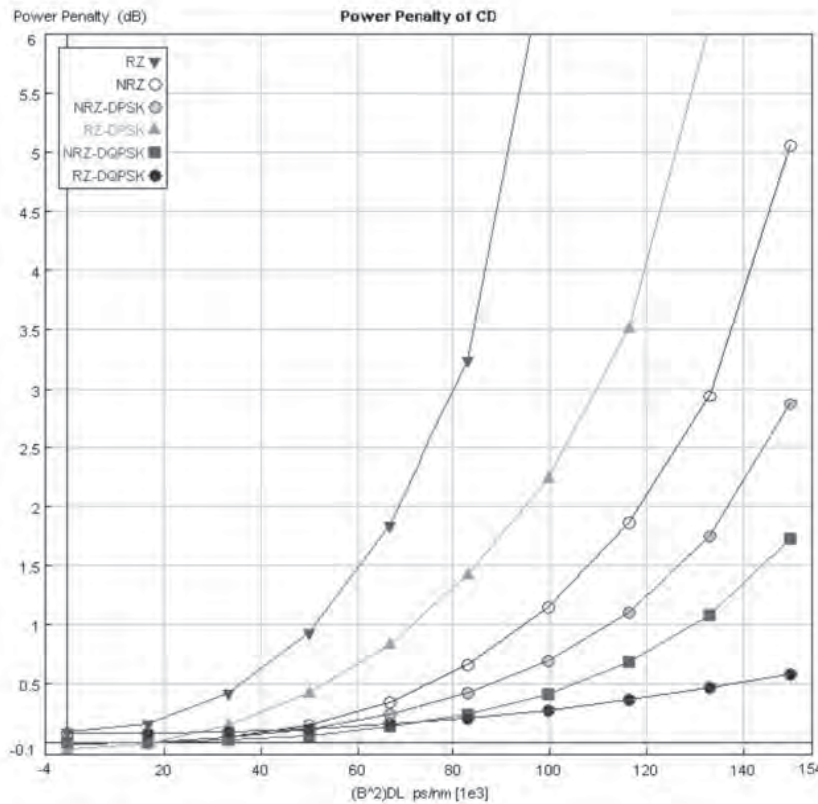

Figure 9. Power Penalty of Chromatic Dispersion.

transmission impairments. Figures 9 and 10 show the power penalty of CD and PMD. Long distance transmissions require a good nonlinear tolerance, because a large signal power is required. However, nonlinear impairments are increased e.g. SPM and intra-channel effects (IXPM, IFWM). The nonlinear effects introduce a penalty resulting in a reduced distance reach. The nonlinear tolerance depends on the characteristics of the modulation format and on the deployed transmission infrastructure. To improve the nonlinear tolerance, it is important to select the appropriate modulation format. In this section, we studied various transmission formats, where the nonlinear tolerance is analyzed. The signal is transmitted down a span of SMF with zero dispersion at 192,1 THz so that any pulse broadening is due to nonlinear impairments only. The Q penalty against the fiber input power can be applied for qualification and characterization of different modulation formats. The resulting Q penalties after the transmission are shown in Figure 11.

It is clear that RZ modulation formats show better nonlinear tolerance compared to NRZ modulation formats. RZ formats have a reduced pulse width, so the pulses disperse faster, reducing the peak power and the impact of nonlinear effects. The steeper pulse edges in NRZ formats cause stronger SPM. But on the other hand, a fast broadening of RZ pulse, enhances pulse-to-pulse interactions (e.g. IXPM), which in periodically compensated transmission links become significantly evident.

The RZ shaped pulses can enable an enhancement of the signal power, meanwhile NRZ and Duobinary formats suffer from reduced nonlinear tolerance. On the other side CSRZ, CSRZ-DPSK, alPNRZ and alPRZ formats enable a performance improvement on nonlinear tolerance compared to RZ formats. The conventional RZ formats can be used with a reduced duty cycle (the pulses disperse faster) and show a better nonlinear tolerance improvement. A RZ pulse with a duty cycle of 33% shows an enhanced nonlinear

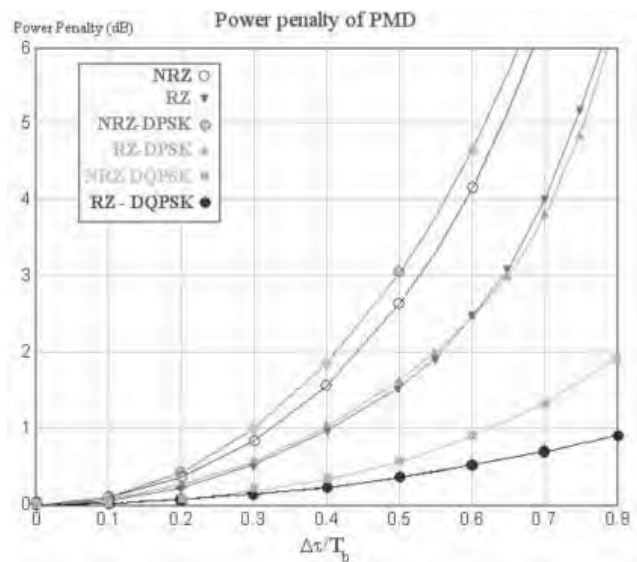

Figure 10. Power Penalty of Polarization Mode Dispersion.

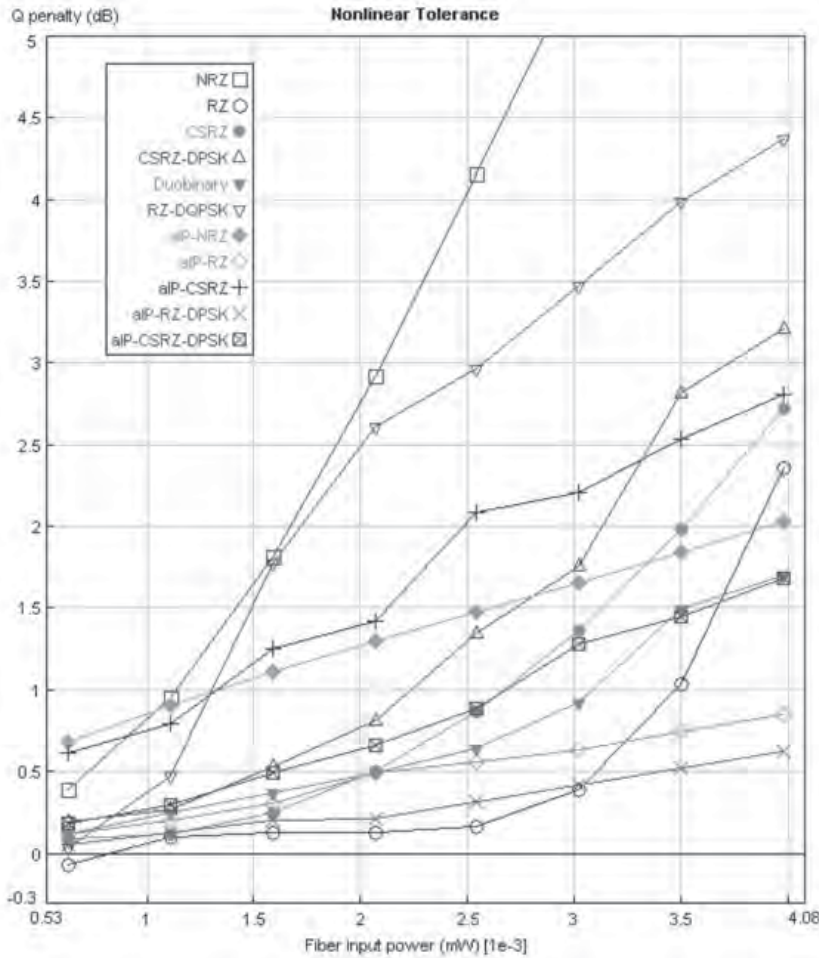

Figure 11. Nonlinear tolerance in single channel transmission over 4x80 km SMF.

tolerance in comparison to RZ 50 % and CSRZ (the RZ pulse has a duty cycle of 66%). However, the RZ with a low duty cycle would be limited to a single channel and WDM transmissions with a reduced spectral width (<0.5 bit/s/Hz), because of the broader optical signal spectrum as a consequence of the narrowing pulse.

The alternate polarization formats shows enhancements that can be explained in the suppression of SPM and the inter-pulse interferences by the orthogonal polarization of adjacent bits and also the nonlinear tolerance is associated with the amount of carrier suppression (depth of the spectral central deep). Figure 12 shows the simulation set-up implemented to analyze the performance of some advanced modu-

lation formats against the length of transmission. We simulated a single channel transmission with 25 spans of NZDSF, full compensated with DCF (80 km of NZDSF, full compensated with 4.6651 km). Figure 13 shows the BER obtained for the different advanced binary modulation formats. We can see that aIP-RZ-DPSK has the best performance of all formats. The CSRZ-DPSK, aIP-NRZ and aIP-RZ formats have a notable better performance in comparison with the traditional NRZ format.

### CONCLUSIONS

The results show that aIP-RZ-DPSK has the best performance in our simulations. This corroborates our last results in the measure of PMD and nonlinear tolerance. The investigations were focused on a 40 Gb/s based single optical transmission system, where the new proposals showed the potential of 40 Gb/s technologies for the implementation of the next generation of optical transmission networks. We studied the traditional ASK-based and the novel modulation formats, where a comparison among the different modulation formats in terms of the total transmission distance, and their tolerance to nonlinear

(e.g. Kerr effect) and linear (e.g. PMD) impairments were realized.

An overview of different transmission components and dominant propagation effects is considered. It was showed that the direct detection for DPSK based-formats is the best election, because its simple configuration of transmitter and receiver for cost-effectiveness. The right selection of the performance evaluation model for the characterization of optical transmission systems represents one of the key issues for an effective design of high speed systems next generation.

The results showed that NRZ-based formats provides a better dispersion tolerance, but suffers from



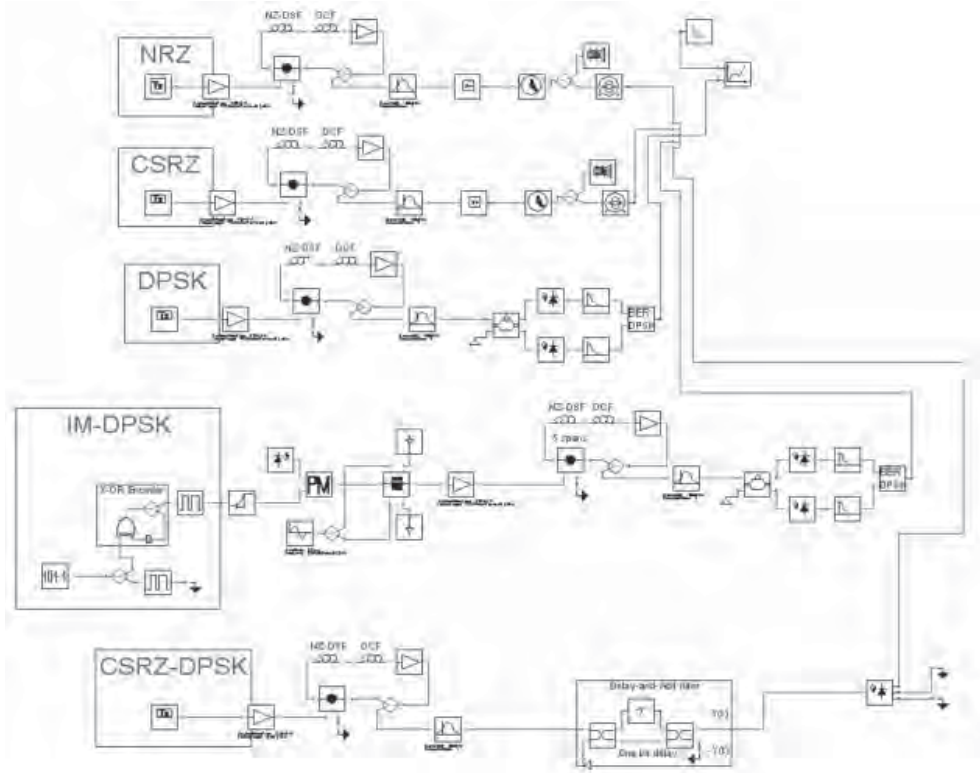

Figure 12. Simulation set-up for the measure of Bit error rate (BER) against the distance of transmission for several advanced modulation formats.



Figura 13. Measured BER for several binary modulation formats at 40 Gb/s.

strong nonlinear limitations. The use of new NRZ-based formats enables a significant improvement of nonlinear impairments at the cost of slightly increased transmitter complexity such as phase modulation (DPSK) and polarization modulation (aP) on traditional NRZ format.

RZ-based formats are characterized by an increased sensitivity to residual dispersion and a significant nonlinear tolerance. When phase or/and polarization modulation is applied to RZ formats, a reduced spectrum and a further improvement of already good nonlinear robustness is obtained, resulting in an increased maximum transmission distance. The modulation formats employing polarization alternating between consecutive pulses are the best solution for the performance in 40 Gb/s single channel transmission.

## REFERENCES

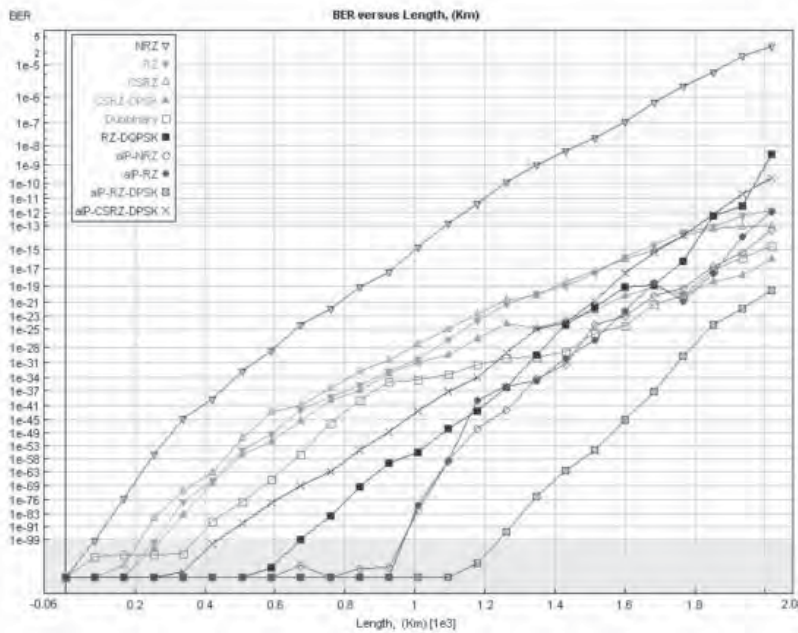
- Furst, C., Mohs, G., Geiger, H. and Fischer, G. (2000). Performance limits of nonlinear RZ and NRZ coded transmission at 10 and 40 Gb/s on different fibers. *Optical Fiber Communication Conference (OFC)*.
- Hayee, M.I. and Willner, A.E. (2003). NRZ versus RZ in 10-40-Gb/s dispersion-managed WDM transmission systems. *IEEE Photonics Technology Letters*.
- Hodžić, A., Beate Knorad, and Petermann, K. (2002). Alternative Modulation Formats in N×40Gb/s WDM Standard Fiber RZ-Transmission Systems. *Journal of Lightwave Technology*, VOL. 20, NO. 4, pp. 598-607.
- Hoshida, T., Vassilieva, O. and Yamada, K. (2002). Optimal 40 Gb/s modulation formats for spectrally efficient long-haul DWDM systems, *Journal of lightwave technology*, Vol. 20, No. 12.
- Hui, R., Zhu, B., Huang, R.C., Allen, K. and Richards, D. (2001). 10Gb/s SCM system using optical single side-band modulation. Paper MM4, *Optical Fiber Communication Conference OFC'2001*, Anaheim, CA.
- Jopson, B., Gnauck, A. (1995). Dispersion compensation for optical fiber systems. *IEEE Communications Magazine*.
- VPI Virtual Photonics. VPI TransmissionMaker (2002). WDM Users's Manual.
- Wang, J., Kahn, J.M. (2004). Conventional DPSK vs. symmetrical DPSK: comparison of dispersion Tolerances, *IEEE Photonics Technology Letters*, vol. 16, pp. 1397-99.
- Wang, J., Kahn, J.M. (2004). Impact of chromatic and polarization-mode dispersion on DPSK systems using interferometric demodulation and direct detection, *IEEE Journal of Lightwave Technology*, vol. 22, no. 2, pp. 362-371.
- Wuth, T., Kaiser, W. and Rosenkranz, W. (2001). Impact of Self-Phase Modulation on Bandwidth Efficient Modulation Formats. *Optical Fiber Communication Conference*.
- Xu, C., Liu, X., Mollenauer, L.F. and Wei, X. (2003). Comparison of Return-to-Zero Differential Phase-Shift Keying and ON-OFF keying in Long-Haul Dispersion Managed Transmission, *IEEE Photonics Technology Letters*, VOL. 15, NO.4.
- Zacharopoulos, I., Parcharidou, D. and Tomkos, I. (2004). Performance Study of Modulation Formats for 10 Gbit/s Metropolitan Area Networks, *IEEE, Photonics Technology Letters*.